

NP2-3000Ah 2V3000Ah

Specifications

Nominal Voltage		2V
Rated capacity (10 hour rate)		3000Ah
Dimensions	Length	710±3mm(27.95inch)
	Width	350±2mm(13.78inch)
	Height	345±2mm(13.58inch)
	Total Height	382±2mm(15.04inch)
Approx. Weight		186kg(410lbs)±3%



Outer dimensions (mm)

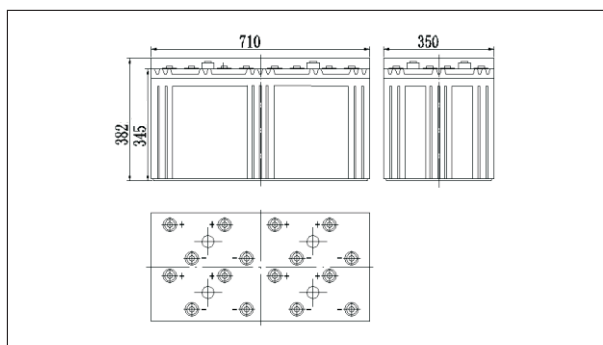

Terminal Type (mm)

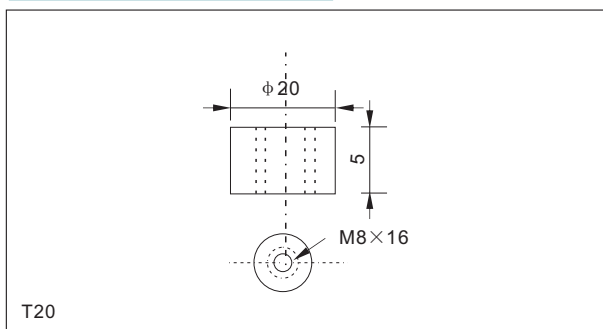

Characteristics

Capacity (25°C)	10HR(1.8V)	3000Ah
	3HR(1.80V)	2250Ah
	1HR(1.75V)	1650Ah
Terminal type		T20
Internal resistance (Fully charged, 25°C)		Approx.0.12m Ω
Capacity affected by temperature (10HR)	40°C	102%
	25°C	100%
	0°C	85%
	-15°C	65%
Self-discharge (25°C)	3 months	Remaining Capacity:91%
	6 months	Remaining Capacity:82%
	12 months	Remaining Capacity:65%
Nominal operating temperature		25°C ±3°C(77°F ±5°F)
Operating temperature range	Discharge	-15°C~50°C(5°F~122°F)
	Charge	-10°C~50°C(14°F~122°F)
	Storage	-20°C~50°C(-4°F~122°F)
Float charging voltage(25°C)		2.25 to 2.30V Temperature compensation: -3mV/°C
Cyclic charging voltage(25°C)		2.40 to 2.50V Temperature compensation: -5mV/°C
Maximum charging current		600A
Maximum discharge current		15000A(5 sec.)
Designed floating life(20°C)		15 years

Construction

Component	Positive plate	Negative plate	Container	Cover	Separator	Electrolyte	Safety valve	Terminal
Raw material	lead dioxide	Lead	ABS	ABS	AGM	Sulfuric acid	Rubber	Copper

Constant Current Discharge Characteristics Unit:A(25°C,77°F)

F.V/Time	30min	60min	2h	3h	4h	5h	6h	8h	10h	20h	24h
1.60V	2730	1890	1105	796	636	548	471	372	307	162	139
1.65V	2675	1833	1099	791	633	545	468	370	306	162	138
1.70V	2594	1777	1089	785	628	541	465	367	305	161	138
1.75V	2531	1720	1073	780	624	537	462	365	304	160	137
1.80V	2438	1663	1045	757	605	521	448	354	302	159	136

Constant Power Discharge Characteristics Unit:W(25°C,77°F)

F.V/Time	30min	60min	2h	3h	4h	5h	6h	8h	10h	20h	24h
1.60V	5105	3591	2133	1559	1248	1079	928	740	611	324	279
1.65V	5003	3483	2121	1550	1240	1073	923	736	610	323	278
1.70V	4850	3376	2102	1540	1232	1065	917	730	608	322	277
1.75V	4732	3268	2070	1529	1223	1058	910	725	604	320	276
1.80V	4559	3160	2018	1483	1186	1026	883	704	600	318	274

Note: The above characteristics data can be obtained within three charge or discharge cycles.

NP2-3000Ah 2V3000Ah

● **Discharge characteristics(25°C)**

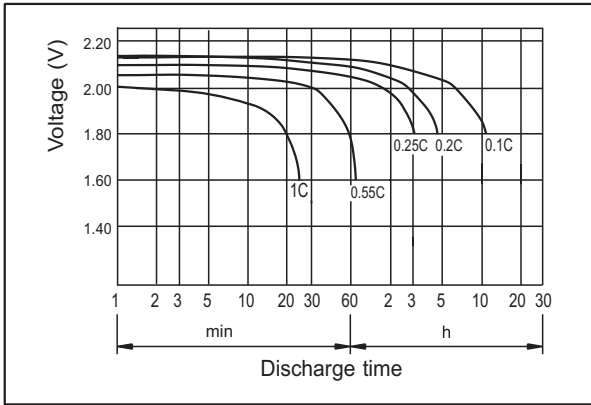

● **Charging characteristics**

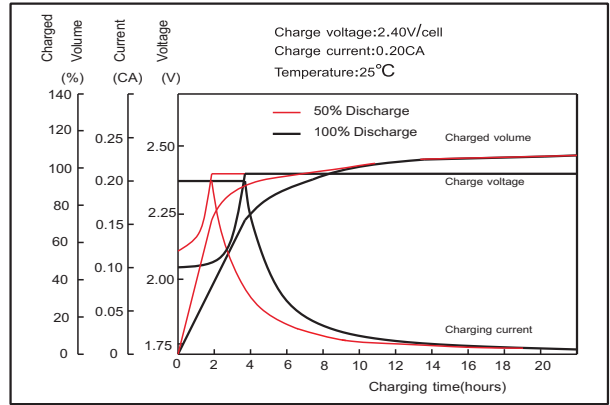

● **Effect of Temperature on Capacity**

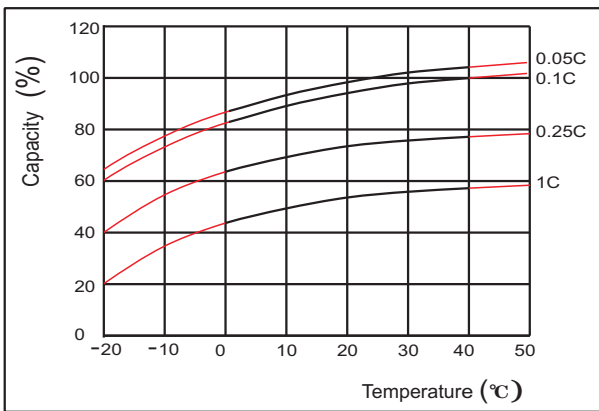

● **Self-discharge characteristics**

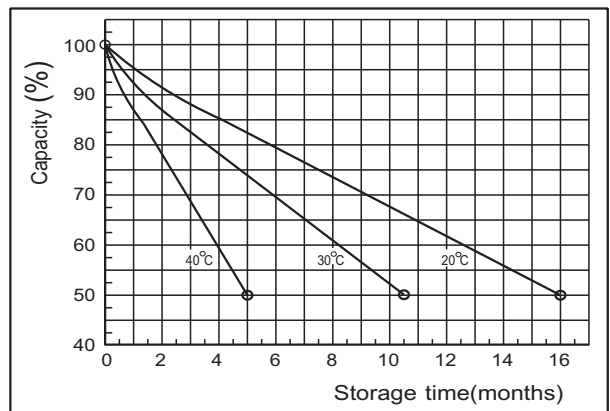

● **Temperature effects on float life**

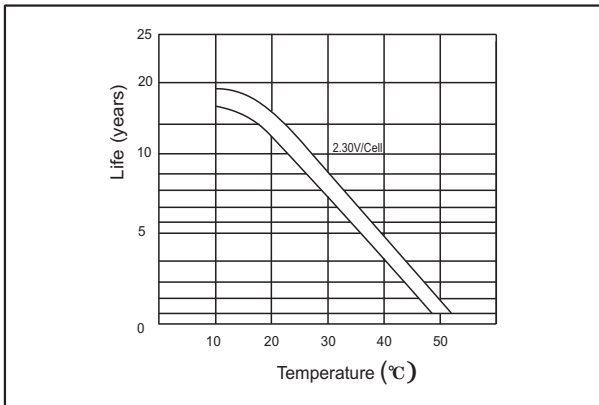

● **Cycle service life in relation to depth of discharge**

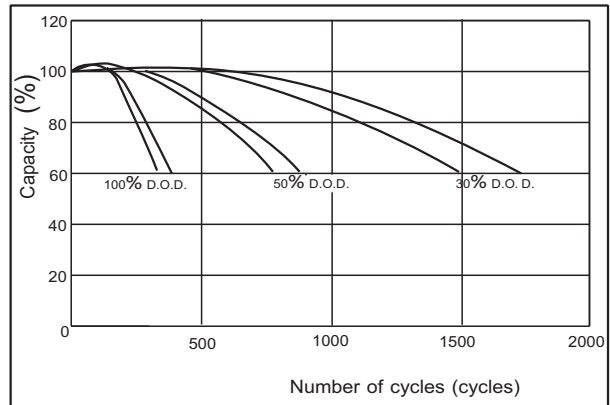

● **The relationship for OCV and Capacity (25°C)**

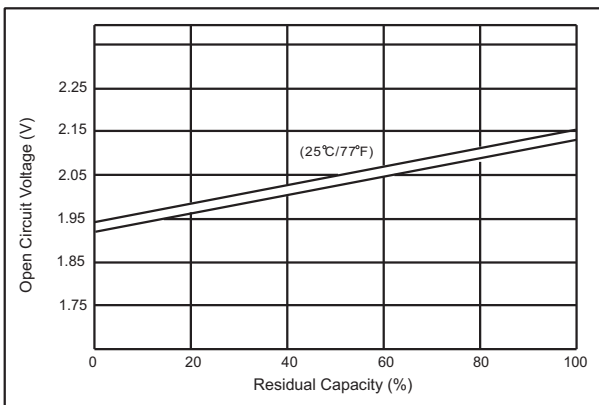

● **The relationship for Charging voltage and Temperature**

