

NP2-150Ah 2V150Ah

Specifications

Nominal Voltage		2V
Rated capacity (10 hour rate)		150Ah
Dimensions	Length	171±2mm(6.73inch)
	Width	102±2mm(4.02inch)
	Height	206±2mm(8.11inch)
	Total Height	221±2mm(8.70inch)
Approx. Weight		8kg(17.6lbs)±4%

Outer dimensions (mm)

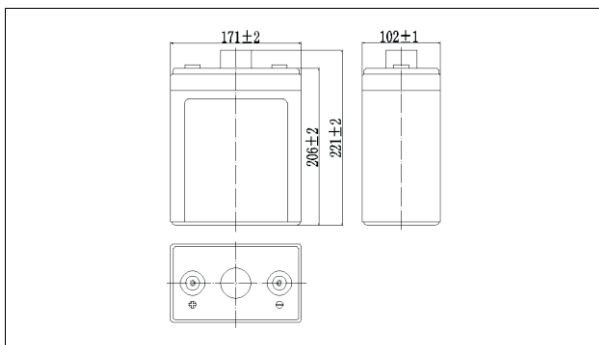

Terminal Type (mm)

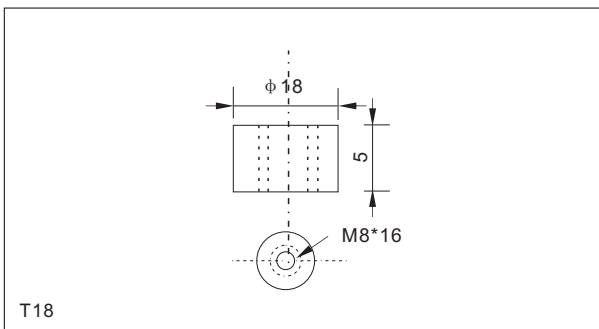

Characteristics

Capacity (25°C)	10HR(1.8V)	150Ah
	3HR(1.80V)	112.5Ah
	1HR(1.75V)	85Ah
Terminal type		T18
Internal resistance (Fully charged, 25°C)		Approx.0.6m Ω
Capacity affected by temperature (10HR)	40°C	102%
	25°C	100%
	0°C	85%
	-15°C	65%
Self-discharge (25°C)	3 months	Remaining Capacity:91%
	6 months	Remaining Capacity:82%
	12 months	Remaining Capacity:65%
Nominal operating temperature		25°C ±3°C(77°F ±5°F)
Operating temperature range	Discharge	-15°C~50°C(5°F~122°F)
	Charge	-10°C~50°C(14°F~122°F)
	Storage	-20°C~50°C(-4°F~122°F)
Float charging voltage(25°C)		2.25 to 2.30V Temperature compensation: -3mV/°C
Cyclic charging voltage(25°C)		2.40 to 2.50V Temperature compensation: -5mV/°C
Maximum charging current		45A
Maximum discharge current		1200A(5 sec.)
Designed floating life(20°C)		10 years

Construction

Component	Positive plate	Negative plate	Container	Cover	Separator	Electrolyte	Safety valve	Terminal
Raw material	lead dioxide	Lead	ABS	ABS	AGM	Sulfuric acid	Rubber	Copper

Constant Current Discharge Characteristics Unit:A(25°C,77°F)

F.V/Time	10min	15min	30min	60min	2h	3h	4h	5h	8h	10h	20h
1.60V	327	252	151	92.7	54.8	39.5	31.5	26.9	18.5	15.3	8.09
1.65V	317	246	148	91.3	54.5	39.2	31.3	26.8	18.4	15.2	8.08
1.70V	304	237	143	89.0	54.0	39.0	31.1	26.6	18.3	15.2	8.05
1.75V	291	229	140	86.2	53.2	38.7	30.9	26.4	18.2	15.1	8.01
1.80V	275	217	135	83.4	51.8	37.5	30.0	25.6	17.6	15.0	7.95

Constant Power Discharge Characteristics Unit:W(25°C,77°F)

F.V/Time	10min	15min	30min	60min	2h	3h	4h	5h	8h	10h	20h
1.60V	589	461	282	176	106	77.4	61.8	53.0	36.7	30.4	16.2
1.65V	571	450	276	173	105	76.9	61.4	52.7	36.4	30.3	16.2
1.70V	547	433	268	169	104	76.4	61.0	52.4	36.2	30.2	16.1
1.75V	524	419	261	164	103	75.9	60.6	52.0	35.9	30.1	16.0
1.80V	494	397	252	159	100	73.6	58.7	50.4	34.9	29.9	15.9

Note: The above characteristics data can be obtained within three charge or discharge cycles.

NP2-150Ah 2V150Ah

Discharge characteristics(25°C)

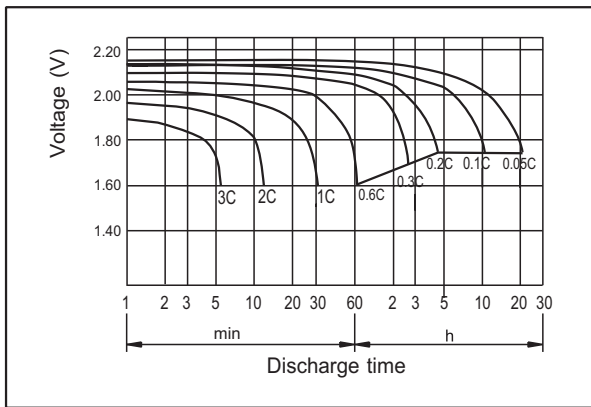

Charging characteristics

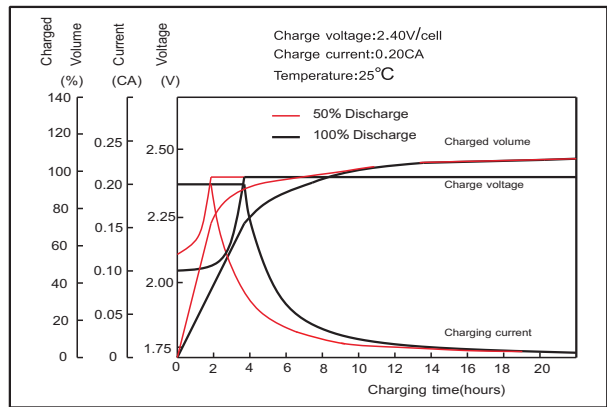

Effect of Temperature on Capacity

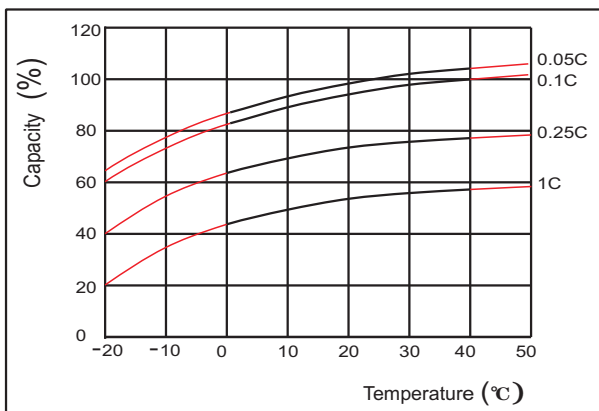

Self-discharge characteristics

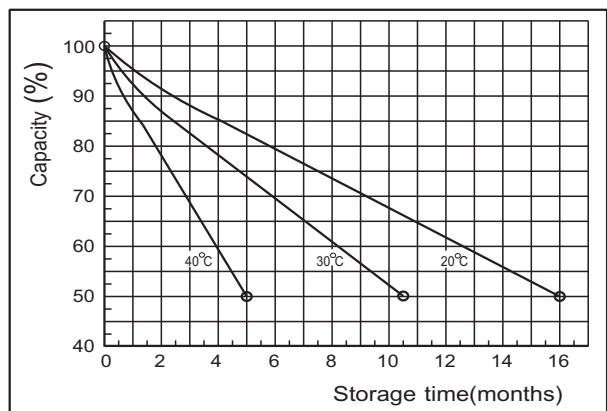

Temperature effects on float life

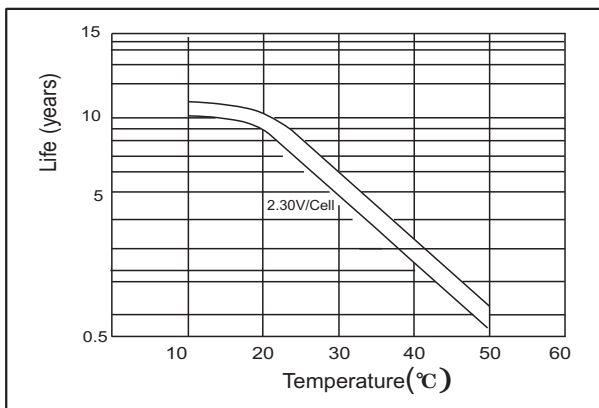

Cycle service life in relation to depth of discharge

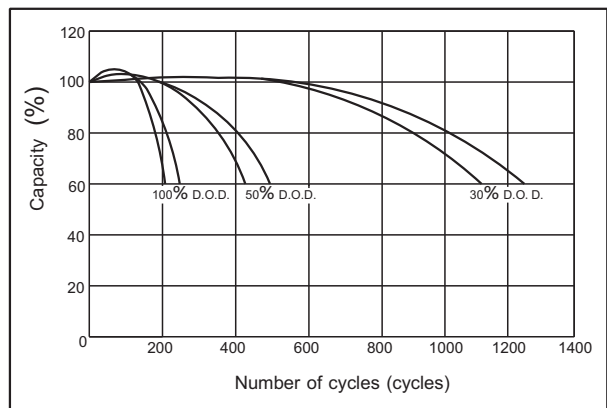

The relationship for OCV and Capacity (25°C)

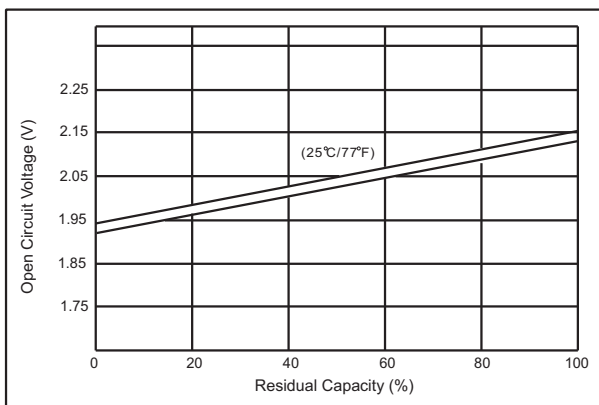

The relationship for Charging voltage and Temperature

