

CyberPower

User's Manual for CyberShield

CSN30C12V-E

CyberShield UPSs are designed to provide a local power solution for cable telephony, wireless local loop (WLL), and fiber to the home (FTTH) broadband equipment.

IMPORTANT SAFETY WARNINGS (SAVE THESE INSTRUCTIONS)

This manual contains important instructions regarding the installation and operation of this device. Read this manual thoroughly before attempting to unpack, install or operate this device.

- CAUTION!** The battery can energize hazardous live parts inside even when the AC input power is disconnected.
- CAUTION!** To reduce the risk of electric shock, keep the cover on. There are no user serviceable parts inside the unit, including the battery. Please contact us or our dealer for service.
- CAUTION!** To avoid electric shock, unplug power cable from the AC power source before servicing the battery or installing a computer component.
- CAUTION!** Power Cable Selection:
A power cable (4.5m max.) being identified as 18AWG, "OUTDOOR" or "WATERPROOF" should be selected while necessary.
- CAUTION!** It is recommended to connect the unit to the required equipment and battery before plugging in the utility power.
- CAUTION!** When replacing batteries, the replacement should have the same rating: Listed/Certified Valve Regulated Lead Acid Battery, 12V, max. 9Ah.
- CAUTION!** Before replacing batteries, remove conductive jewelry, such as chains, watches and rings, and use tools with insulated handles. High energy passed through conductive materials can cause severe burns.
- CAUTION!** Don't dispose of batteries in a fire. Batteries may explode if improperly disposed. Recycle batteries in accordance with local regulations.
- CAUTION!** The UPS battery is charging when it's connected to utility power. The battery is charging during its first 24 hours of normal operation. Don't expect full battery capacity during this initial charging period.
- CAUTION!** Runtimes based on testing fully-charged, new batteries at normal operating conditions. Runtime curve is approximate and varies based on battery age, level of charge at test, environment, and other variables.
- CAUTION!** Keep the gap around the UPS for air circulation.

INSTALLATION

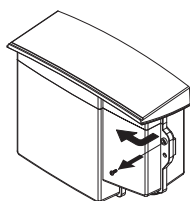

- Step 1:
- a. Remove the case screw.
 - b. Open the battery cover.

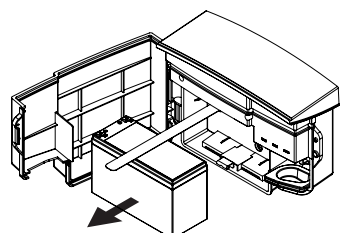

- Step 2:
- a. Loosen strap from battery.
 - b. Slide battery off of the shelf.
 - c. Remove battery cable connector.

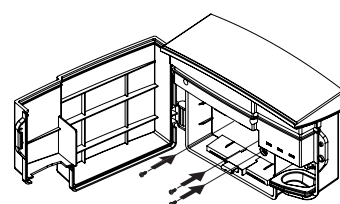

- Step 3:
- a. Use the enclosed installation template to mark an installation location for the unit.
 - b. The unit can only be wall-mounted in one direction with the connector facing down.
 - c. Mount the unit on the wall with 3 mounting screws into the keyhole slots.
 - d. Tighten the screws to secure the unit.
 - e. Reconnect the battery cable connector and place the battery back.

Recommend Screw Dimension

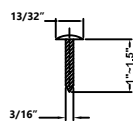

BATTERY REPLACEMENT

This battery is hot-swappable. As long as utility power is on, you may leave the Battery Backup Power Supply and connected equipment on while replacing a new battery.

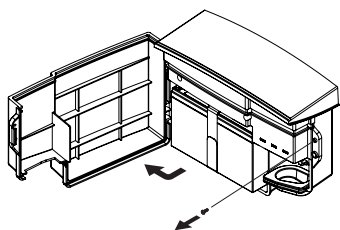

- Step 1:
- a. Remove the case screw.
 - b. Open the battery cover.

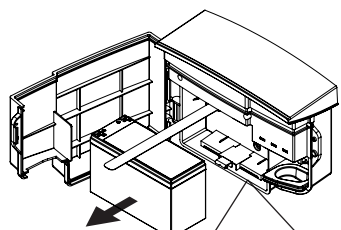

- Step 2:
- a. Loosen the battery strap.
 - b. Disconnect battery cable connector to remove battery.
 - c. Replace with new battery and reconnect the battery connector.

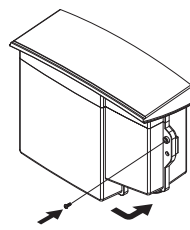

- Step 3:
- a. Tighten the battery strap.
 - b. Close the battery cover and lock the case screw.

OPERATION

Please refer to the following recommendations to connect equipment and power source.

- Step1. Refer to the *BATTERY REPLACEMENT* to connect the battery.
- Step2. Refer to the *COMMUNICATION SIGNALS* to setup the connector and connect equipment to the UPS.
- Step3. Plug the UPS power cord into the utility power cord inlet.
- Step4. Plug the UPS power cord into the wall outlet.

COMMUNICATION SIGNALS

The communication signals of this unit are isolated from the internal circuitry via open collector opto-coupled transistors. The connection "SIG RTN" (Signal Return) is a common return point for all communication signals. In the typical application, the attached equipment digital ground connects to Signal Return, and pull-up resistors turn the open collector signals into logic levels.

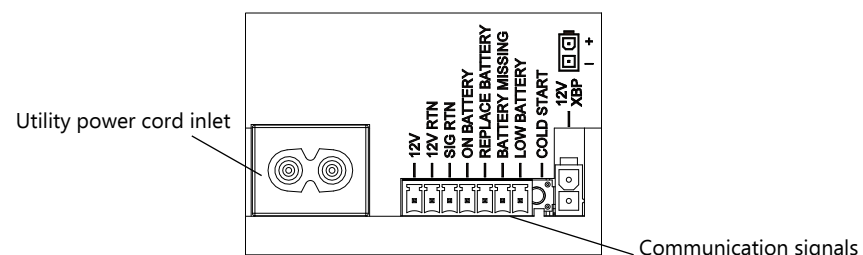



Signal	Message
12V	+ Voltage output
12V RTN	- Voltage output
SIG RTN	Signal return
ON BATTERY	Low when operating from utility line. Open when operating from battery.
REPLACE BATTERY	Low when battery is charged. Open when battery fails the Self Test.
BATTERY MISSING	Low when battery is present. Open when battery is missing.
LOW BATTERY	Low when battery is near full charge capacity. Open when operating from a battery with < 10% capacity.

COLD START

The cold start feature is for applying power to the Battery Backup Power Supply and connected equipment when the Battery Backup Power Supply is off and there is no utility power. Before using the cold start feature, please make sure the battery is charged. To enable the cold start feature, press the recessed cold start button with a small pointed object.

WARNING INDICATOR

Indicator	Color	Condition
 AC	Green	Battery Backup Power Supply is on utility power.
	Yellow	Battery Backup Power Supply is on battery power.
 OUTPUT	Green	DC output power is provided by the battery or utility power.
 BATTERY	Red	The battery is not connected or the battery needs to be replaced.

• Front Panel

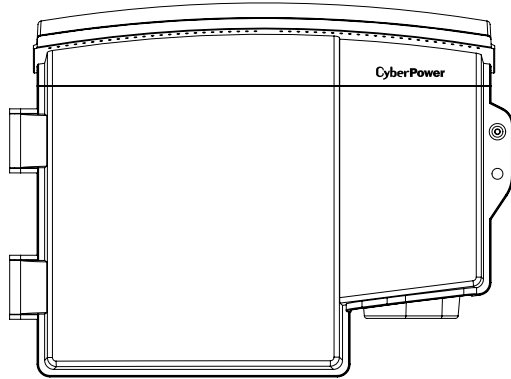

• Back Panel

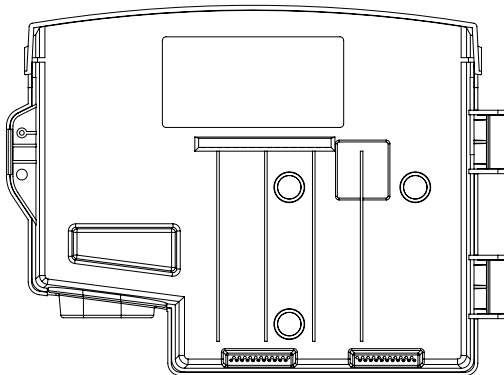

SPECIFICATION

Model	CSN30C12V-E
Input	
Voltage Range	100 - 240V _{AC}
Frequency Range	50 - 60 Hz
Output	
On Battery Output Voltage	12V _{DC}
Continuous Power Capability	30W
Output Power Max	30W
Efficiency	>80%
Battery	
Battery Type	Sealed, Maintenance Free Lead-Acid Battery
Numbers of Battery	7.2Ah / 12V x 1
Typical Recharge Time	18Hours to 90% (no load)
Replaceable	Yes
Surge Protection and Filtering	
Lightning / Surge Protection	Yes
Warning Diagnostics	
Indicators	AC, Output, Battery
Management	
Auto-Charge	Yes
Communication Interface	On Battery, Replace Battery, Battery Missing, Low Battery
Physical	
Maximum Dimensions (L*W*D)	27.5cm x 20.4cm x 9.9cm
Weight (kg)	3.51
Environment	
Operating Temperature	-4°F - 122F(-20°C - 50°C)
Operating Humidity	0 - 95% noncondensing within enclosure
Max Operating Elevation	10,000ft (3,048m)
Max Storage Elevation	50,000ft (15,240m)
Storage Temperature	-4°F - 122F(-20°C - 50°C)

LIMITED WARRANTY

CyberPower warrants to you, the Initial Purchaser, that the Product will be free from defects in material and workmanship for three years from the date of original purchase, subject to the terms of this Limited Warranty. This Limited Warranty gives you specific rights, and you may have other rights, which vary from State to State or Province to Province.

Any Implied Warranty of Merchantability or for Fitness for a Particular Purpose, if applicable to the Product, is limited in duration to three years. This provision shall NOT create any Implied Warranty or Merchantability or of Fitness for a Particular Purpose that would not otherwise apply to the Product. NOTE: **Some States and Provinces do not allow limitations on how long an implied warranty lasts, so the above limitation may not apply to you.**

To be covered you must still be the owner of the Product at the time of the failure that results in the claim made under this Limited Warranty. Your sole and exclusive remedies are those provided by this Limited Warranty. This exclusion of other express warranties applies to written and oral express warranties. CyberPower excludes any liability for personal injury. CyberPower excludes any liability for direct, indirect, special, incidental, or consequential damages, whether for damage to or loss of property, loss of profits, business interruption, information or data. This exclusion applies even though damage or loss is caused by negligence or other fault. NOTE: Some States or Provinces do not allow the exclusion or limitation of incidental or consequential damages, so the above limitation may not apply to you.

DO NOT USE FOR MEDICAL OR LIFE SUPPORT EQUIPMENT OR OTHER HIGH RISK ACTIVITIES.

CyberPower does not sell the PRODUCT for use in high-risk activities. The PRODUCT is not designed or intended for use in hazardous environments requiring fail-safe performance, including the operation of nuclear facilities, aircraft navigation or communication systems, air traffic control, weapons systems, life support or medical applications or for use in any circumstance in which the failure of the PRODUCT could lead directly to death, personal injury, or severe physical or property damage, or that would affect operation or safety of any medical or life support device (collectively, "High Risk Activities").

CyberPower expressly disclaims any express or implied warranty of fitness for High Risk Activities. CyberPower does not authorize use of any PRODUCT in any High Risk activities.

ANY SUCH USE IS IMPROPER AND IS A MISUSE OF A CYBERPOWER PRODUCT.

The Limited Warranty is governed by the laws of the United States and the State of Minnesota, without reference to conflict of law principles. The application of the United Nations Convention of Contracts for the International Sale of Goods is expressly excluded

FCC NOTICE:

This equipment has been tested and found to comply with the limits for a Class B digital device, pursuant to part 15 of the FCC Rules. These limits are designed to provide reasonable protection against harmful interference in a residential installation. This equipment generates, uses and can radiate radio frequency energy and, if not installed and used in accordance with these instructions, may cause harmful interference to radio communications. However, there is no guarantee that interference will not occur in a particular installation. If this equipment does cause harmful interference to radio or television reception, which can be determined by turning the equipment off and on, the user is encouraged to try to correct the interference by one or more of the following measures: (1) Reorient or relocate the receiving antenna. (2) Increase the separation between the equipment and receiver. (3) Connect the equipment into an outlet on a circuit different from that to which the receiver is connected. (4) Consult the dealer or an experienced radio/TV technician for help.

CAUTION: Shielded signal cables must be used with this device to ensure compliance with Class B FCC limits.

CAUTION: Any changes or modifications not expressly approved by Cyber Power could void the authority granted by the FCC to operate this equipment.



Deliver spent batteries to a recycling facility or ship to the manufacturer in the replacement battery packing material.

For more information, please contact:

CyberPower Systems (USA), Inc. 4241 12th Avenue East, Suite 400, Shakopee, MN55379

Phone: (952)403-9500 Fax: (952)403-0009

www.cpsww.com

CyberPower Systems (EUROPE), Inc. Flight Forum 3545, 5657DW Eindhoven, The Netherlands

E-mail: sales@cyberpower-eu.com

eu.cyberpowersystems.com

CyberPower